

# **12X NDI FHD PTZ Video Camera**

## **User Manual**

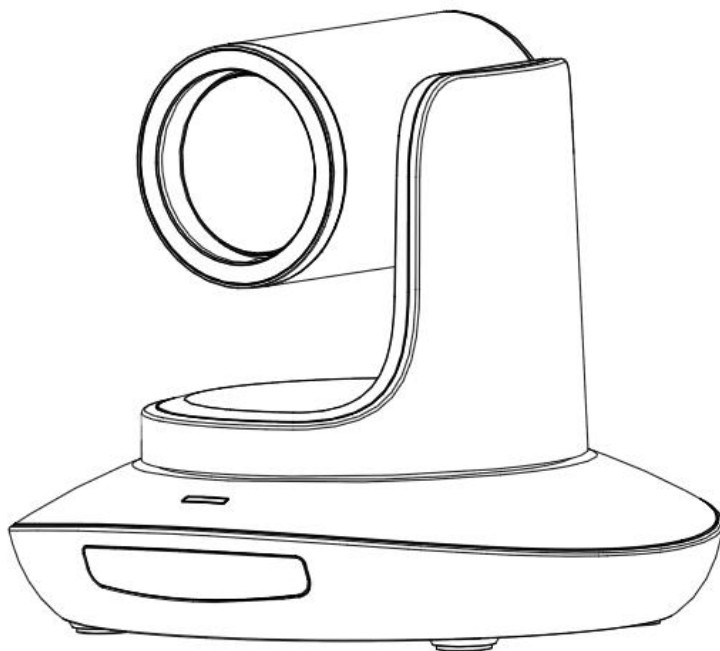

**Version V4.0**  
**(English)**

J.BC.0205.0099



# CONTENT

CONTENT .....	1
SAFETY GUIDES .....	2
PACKING LIST .....	3
QUICK START .....	3
PRODUCT HIGHLIGHTS .....	4
CAMERA SPEC .....	4
CAMERA INTERFACE .....	6
CAMERA DIMENSION .....	6
IR REMOTE CONTROLLER .....	7
VISCA IN (RS232 PORT) .....	9
VISCA PROTOCOL .....	10
PELCO-D PROTOCOL .....	19
PELCO-P PROTOCOL .....	20
OSD MENU .....	21
UVC CONTROL .....	24
WEB SETTING .....	25
VIEW RTSP VIDEO VIA VLC .....	30
NEWTEK TOOLS GUIDE .....	31
VISCA OVER IP .....	33

## SAFETY GUIDES

1. Before operation, please fully read and follow all instructions in the manual. For your safety, always keep this manual with the camera.
2. The camera power input range is 100-240V AC(50-60Hz),ensure the power supply input within this rate before powering on.
3. The camera power voltage is 12V DC, rated currency is 2A. We suggest you use it with the original power supply adapter supplied by the factory.
4. Please keep the power cable, video cable and control cable in a safe place. Protect all cables especially the connectors.
5. Operational environment: 0°C-50°C, humidity less than 90%.To avoid any danger, do not put anything inside the camera, and keep away from the corrosive liquid.
6. Avoid stress, vibration and damp during transportation, storage and installation.
7. Do not detect the camera housing and cover. For any service, please contact authorized technicians.
8. Video cable and control cable should be individually shielded, and cannot be substituted with other cables. Do not direct the camera lens towards strong light, such as the sun or the intensive light.
9. Use a dry and soft cloth to clean the camera housing. Applied with neutral cleaning agent when there is need to clean. To avoid damage on the camera lens, never use strong or abrasive cleaning agents on the camera housing.
10. Do not move the camera by holding the camera head. To avoid mechanical trouble, do not rotate the camera head by hand.  
NEVER MOVE THE CAMERA MANUALLY WHEN IT IS WORKING.
11. Put the camera on fixed and smooth desk or platform, avoid leaned installation.
12. Power Supply Polarity (Drawing)

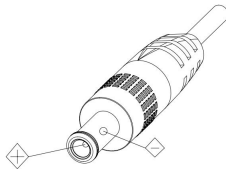

### Note:

The video quality may be affected by the specific frequencies of electromagnetic field. Never grasp the head of the camera, and never move the camera by hand when it is working, otherwise, mechanism maybe destroyed.

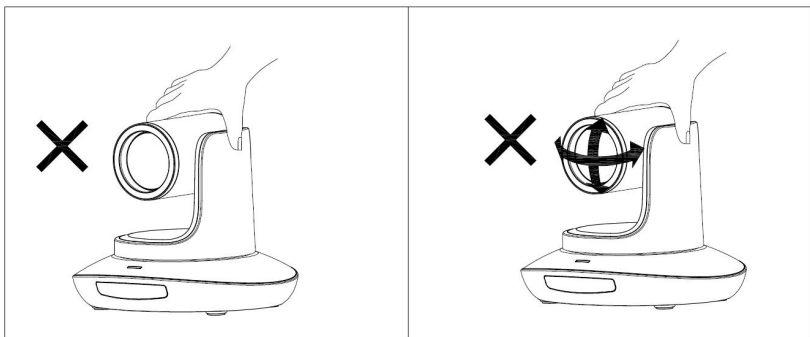

# PACKING LIST

Check all below items when open the package:

Camera.....	1
Power Adapter.....	1
Power Cable.....	1
RS232 Control Cable.....	1
USB3.0 Cable.....	1
Remote Controller.....	1
User Manual.....	1
Double-sided Adhesive.....	1
QC certification.....	1

# QUICK START

1. Check all cable connections before power on.

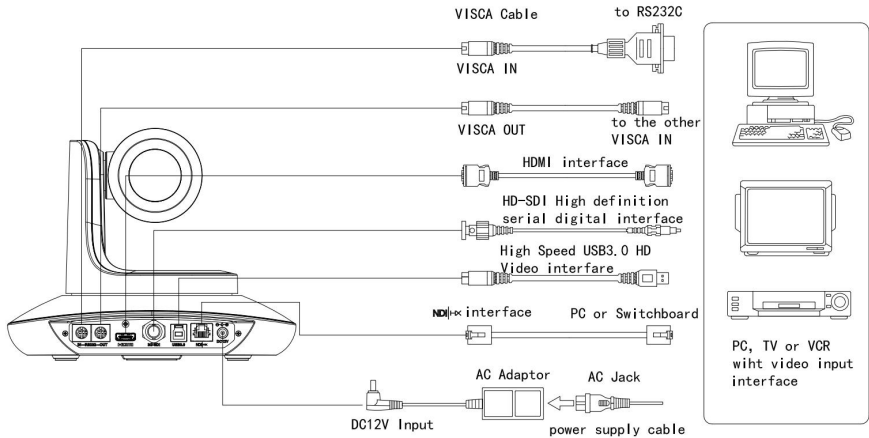

2. Dial Switch Setting (at the bottom of the camera):

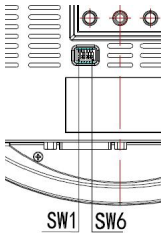

Dial Switch (ARM)			
	SW-1	SW-2	Instruction
1	OFF	OFF	Updating mode
2	ON	OFF	Debugging mode
3	OFF	ON	Undefined
4	ON	ON	Working mode

Dial Switch			
	SW-3	SW-4	Instruction
1	OFF	OFF	reserve
2	ON	OFF	reserve
3	OFF	ON	reserve
4	ON	ON	reserve

Dial Switch (USB)			
	SW-5	SW-6	Instruction
1	OFF	OFF	Updating mode
2	ON	OFF	Working mode
3	OFF	ON	Undefined
4	ON	ON	Undefined

## PRODUCT HIGHLIGHTS

- Adopts most advanced ISP, 1/2.8 inch 2.4MP sensor, providing 1080P60 full HD video resolution.
- Standard wide angle optical lens: 12x optical zoom , with 72.5 degree field of view.
- 1080p60 video over IP, H.264, H.265 encoding.
- Support NewTek NDI V4.5 video transmission and control.
- NDI|HX, HDMI, 3G-SDI, USB outputs, fit for different application.
- White Balance, Exposure, Focus, Iris can be adjusted automatically or manually.
- Support POE: one single CAT5/6 to get video, control and power supply.
- Special Focusing Algorithm: fast and precise focusing performance when zooming or moving.
- Smooth PTZ mechanical design, accurate pan tilt motor control.
- 128 presets supported; Exposure parameter and white balance parameter can be saved in presets (in manual mode).
- Standard Sony VISCA, IP VISCA, PELCO-P, PELCO-D control protocol; IP VISCA over both TCP and UDP.
- Daisy chain supported, max 7 cameras connected in VISCA protocol.
- Image flip function, support upside-down installation.
- Fast video format switch: less than 3 seconds.
- Supported field upgrade for ISP, ARM, FPGA and USB.
- USB3.0 port compatible with USB2.0 output.
- Support RS232/RS485/UVC control.
- Standard UVC1.5 protocol, seamlessly compatible with major video conferencing software and platform.
- OSD menu in English and Chinese supported. IP address, streaming resolution and size can be set in OSD menu.

## CAMERA SPEC

Video Format	HDMI	1920*1080P60/50/30/25/59.94/29.97/24 1920*1080i60/50/59.94 1280*720P60/50/30/25/59.94/29.97
	SDI	1920*1080P60/50/30/25/59.94/29.97/24 1920*1080i60/50/59.94 1280*720P60/50/30/25/59.94/29.97
	USB	1920*1080P60/50/30/25(USB3.0) 1280*720P60/50/30(USB3.0) 1280*720P25(USB3.0&USB2.0) 1024*576P30(USB3.0&USB2.0) 960*540P30(USB2.0) 640*360P30(USB2.0) 512*288P30(USB2.0)
	IP	Main Stream: 1920*1080@3~60; 1280*720@3~60; 1024*576@3~60 Sub Stream: 1280*720@3~60; 1024*576@3~60; 640*360@3~60
	NDI	1920*1080@3~60; 1280*720@3~60; 1024*576@3~60; 640*360@3~60 (low bandwidth mode)
Video Interface	HDMI, SDI, NDI HX, USB3.0,USB2.0	
Sensor	1/2.8"2.4MP CMOS sensor	
Zoom	f 3.92 ~ 47.32mm(12X), F1.8- 2.8, View Angle: 72.5°(Far)-6.3°(Near)	
Rotation Angle	Pan: -170° ~ +170°;	Tilt: -30° ~ +90°
Rotation Speed	Pan: 0°~120°/s ;	Tilt: 0°~80°/s
Preset:	Remote controller: 10; RS232: 128; Accuracy: 0.1°	
Control Port	RS232, RS485, NDI HX(VISCA over IP), USB3.0(UVC1.5), USB2.0(UVC1.1)	

Network Speed	1000M
Video encode	H.264/H.265
Bit Rate Control	Variable Bit Rate, Constant Bit Rate
Video Bit Rate	1024Kbps~16384Kbps
Supported Protocol	TCP/IP, HTTP, RTSP, DHCP, RTMP, Onvif, NDI(V4.5), VISCA over IP(TCP&UDP), HTML5, VISCA, PELCO P/D
POE+	Supported
NDI	Supported
Daisy Chain	Support RS232 serial daisy chain
Minimum Lux	0.1lux
White Balance	ATW/Manual/Auto/Indoor/Outdoor/Push
Exposure	Auto/Manual/Shutter/Iris/Bright
Focus	Auto/Manual
Iris	Auto/Manual
Electric Shutter	Auto/Manual
Gamma	Supported
WDR	Supported
BLC	Supported
2D Noise Reduction	Supported
3D Noise Reduction	Supported
Anti Flicker	OFF/50Hz/60Hz
Pan Tilt Flip	Supported
Input Voltage	DC12V/POE+(IEEE802.3at)
Dimension	220mm×190mm×173mm
Net Weight	1.40kg

## CAMERA INTERFACE

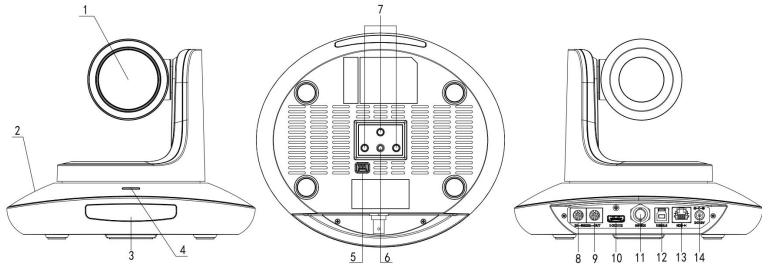

1. Camera Lens
2. Camera Base
3. IR Receiver Panel
4. Power Indicator Light
5. Dial Switch

6. Tripod Screw Hole
7. Installation Hole
8. RS232 control port (input)
9. RS232 control port(output)
10. HDMI port

11. 3G-SDI port
12. USB3.0 port
13. NDI|HX port
14. DC12V plug

## CAMERA DIMENSION(MM)

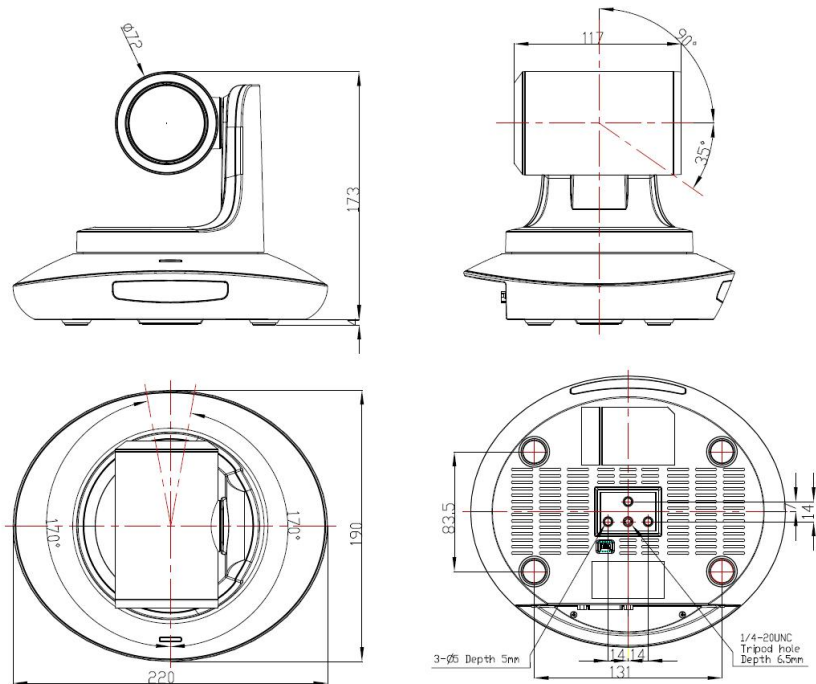



# IR REMOTE CONTROLLER



## POWER

Under normal working mode, short press POWER key, to enter standby mode. Press it again, the camera will do self-configuration, then go back to HOME position. It will go to preset position if power on model has been set before.

## FREEZE (Not Supported in USB)

Short press FREEZE key to freeze/ unfreeze the image.

## IRT (IR Transfer/IR Pass)

Open / close the IR pass function. Once press the IRT key, the camera will receive and Pass the IR remote control signal to the codec/terminal (via VISCA IN port).



## SET 1-SET4 ADDRESS SETTING

Long press for 3seconds until the key light ON, to set camera address.

## CAM1-CAM4 (CAMERA SELECTING)

Short press to select the relative camera.

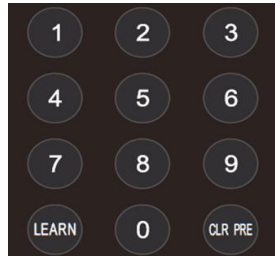

## NUMBER KEY (1-9)

Set preset: long press (3 seconds) the number key to set preset.  
Run preset: Short press the number key to run preset.

## CLR PRE (CLEAR PRESET)

CLR PRE+ number key: to clear the relative preset.  
Long press to clear all preset.



### FOCUS KEY ( ON THE LEFT)

Manual focus, only valid under manual focus model.

### ZOOM KEY( ON THE RIGHT SIDE)

Set the zoom rate.

### NAVIGATE KEY: UP/DOWN/LEFT/RIGHT

Under working mode, use navigate key to set the pan tilt, and select menu when enter OSD.

### OK /HOME KEY

Under working mode, short press OK to make the camera go back to HOME position; and confirm the selection when enter OSD.



**AF:** Auto Focus.

**MF:** Manual Focus.

**RESET:** Press 3 seconds to reset camera.

**MENU:** Enter OSD menu.



**LEARN+LIMIT L key:** Set the pan tilt left limit position.

**LEARN+LIMIT R key:** Set the pan tilt right limit position.

**LEARN+LMT CLR key:** Clear the limit position.

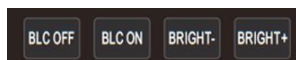

**BLC OFF/ BLC ON:** Not Available.

**BRIGHT-/BRIGHT+:** Set image brightness, only valid under bright priority exposure mode.



### Video Format Keys:

Long press 3 seconds to select different video format output.

## VISCA IN (RS232 PORT)

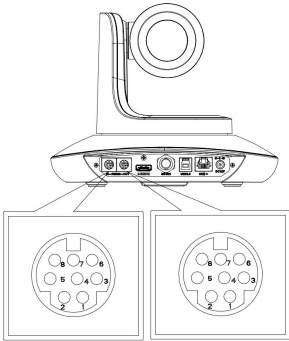

No.	V_IN	V_OUT
1	DTR	DTR
2	DSR	DSR
3	TXD	TXD
4	GND	GND
5	RXD	RXD
6	A	
7	IR OUT	
8	B	

VISCA IN	RS485
1	
2	
3	
4	
5	
6	A(+)
7	IR OUT
8	B(-)

### VISCA IN & Mini DIN Connection

Camera VISCA IN		Mini DIN	
1	DTR	1	DSR
2	DSR	2	DTR
3	TXD	5	RXD
4	GND	4	GND
5	RXD	3	TXD
6	A(+)	6	NC
7	IR OUT	7	NC
8	B(-)	8	NC

### VISCA IN & DB9 Connection

Camera VISCA IN		Windows DB-9	
1	DTR	6	DSR
2	DSR	4	DTR
3	TXD	2	RXD
4	GND	5	GND
5	RXD	3	TXD
6	A(+)		
7	IR OUT		
8	B(-)		

### VISCA Network Construction:

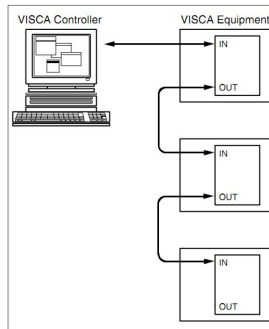

### SERIAL PORT CONFIGURATION

Parameter	Value	Parameter	Value
Baud rate	2400/4800/9600/115200	Stop Bit	1bit
Start Bit	1 bit	Check Bit	None
Date Bit	8 bit		

# VISCA PROTOCOL

## Part1 Camera Return Command

Ack/Completion Message		
	Command Packet	Note
ACK	z0 41 FF	Returned when the command is accepted.
Completion	z0 51 FF	Returned when the command has been executed.

z = camera address+8

Error Messages		
	Command Packet	Note
Syntax Error	z0 60 02 FF	Returned when the command format is different or when a command with illegal command parameters is accepted
Command Not Executable	z0 61 41 FF	Returned when a command cannot be executed due to current conditions. For example, when commands controlling the focus manually are received during auto focus.

## Part 2 Camera Control Command

Command type	function	command		
Address Set	Broadcast	88 30 01 FF	Address setting	
IF_Clear	Broadcast	88 01 00 01 FF	I/F Clear	
Command Cancel		8x 21 FF		
CAM_Power	On	8x 01 04 00 02 FF	Power ON/OFF	
	Off	8x 01 04 00 03 FF		
CAM_Zoom	Stop	8x 01 04 07 00 FF	p = 0(low)~7(high)	
	Tele(Standard)	8x 01 04 07 02 FF		
	Wide(Standard)	8x 01 04 07 03 FF		
	Tele(Variable)	8x 01 04 07 2p FF		
	Wide(Variable)	8x 01 04 07 3p FF		
	Direct	8x 01 04 47 0p 0q 0r 0s FF		pqrs: Zoom Position (0(wide)~0x4000(tele))
	Direct with speed	8x 0A 04 47 0t 0p 0q 0r 0s FF		t: spd 0~7 pqrs: Zoom Position (0(wide)~0x4000(tele))
CAM_DZoom	ON	8x 01 04 06 02 FF		
	OFF	8x 01 04 06 03 FF		
	Combine Mode	8x 01 04 36 00 FF	Combine with optical zoom control	
	Separate Mode	8x 01 04 36 01 FF	Separate with optical zoom control	
	Stop	8x 01 04 06 00 FF	Enable In separate mode	
	Tele (Variable)	8x 01 04 06 2p FF	Enable In separate mode	
	Wide (Variable)	8x 01 04 06 3p FF	Enable In separate mode	
	Direct	8x 01 04 46 0p 0q 0r 0s FF	Enable In separate mode	
	Stop	8x 01 04 08 00 FF		

Command type	function	command	
CAM_Focus	Far(Standard)	8x 01 04 08 02 FF	
	Near(Standard)	8x 01 04 08 03 FF	
	Far (Variable)	8x 01 04 08 2p FF	p=0 (Low) to 7 (High)
	Near (Variable)	8x 01 04 08 3p FF	p=0 (Low) to 7 (High)
	Direct	8x 01 04 48 0p 0q 0r 0s FF	pqrs: Focus Position
	Auto Focus	8x 01 04 38 02 FF	
	Manual Focus	8x 01 04 38 03 FF	
	One Push AF	8x 01 04 18 01 FF	
CAM_Zoom Focus	Direct	8x 01 04 47 0p 0q 0r 0s 0t 0u 0v 0w FF	pqrs: Zoom Position (0(wide)~ 0x4000(tele)) tuvw: Focus Position
CAM_WB	Auto	8x 01 04 35 00 FF	
	Indoor	8x 01 04 35 01 FF	
	Outdoor	8x 01 04 35 02 FF	
	One Push	8x 01 04 35 03 FF	
	ATW	8x 01 04 35 04 FF	
	Manual	8x 01 04 35 05 FF	
	Sodium lamp	8x 01 04 35 08 FF	
	fluorescent	8x 01 04 35 09 FF	
	One Push Trigger	8x 01 04 10 05 FF	
CAM_R Gain	Reset	8x 01 04 03 00 FF	Manual Control of R Gain
	Up	8x 01 04 03 02 FF	
	Down	8x 01 04 03 03 FF	
	Direct	8x 01 04 43 00 00 0p 0q FF	pq: R Gain (0~0xFF)
CAM_B gain	Reset	8x 01 04 04 00 FF	Manual Control of B Gain
	Up	8x 01 04 04 02 FF	
	Down	8x 01 04 04 03 FF	
	Direct	8x 01 04 44 00 00 0p 0q FF	pq: B Gain (0~0xFF)
CAM_AE	Full Auto	8x01 04 39 00 FF	Automatic Exposure mode
	Manual	8x 01 04 39 03 FF	Manual Control mode
	Shutter Priority	8x 01 04 39 0A FF	Shutter Priority Automatic Exposure mode
	Iris Priority	8x 01 04 39 0B FF	Iris Priority Automatic Exposure mode
	Bright	8x 01 04 39 0D FF	Bright Mode (Manual control)
CAM_Shutter	Reset	8x 01 04 0A 00 FF	Shutter Setting
	Up	8x 01 04 0A 02 FF	

Command type	function	command	
	Down	8x 01 04 0A 03 FF	
	Direct	8x 01 04 4A 00 00 0p 0q FF	pq: Shutter Position (0~0x15)
CAM_Iris	Reset	8x 01 04 0B 00 FF	Iris Setting(0~0xD)
	Up	8x 01 04 0B 02 FF	
	Down	8x 01 04 0B 03 FF	
	Direct	8x 01 04 4B 00 00 0p 0q FF	pq: Iris Position (0~ 0x11)
CAM_Gain	Reset	8x 01 04 0C 00 FF	Gain Setting (0~0x0F)
	Up	8x 01 04 0C 02 FF	
	Down	8x 01 04 0C 03 FF	
	Direct	8x 01 04 0C 00 00 0p 0q FF	pq: Gain Positon (0~0x0E)
CAM_Bright	Reset	8x 01 04 0D 00 FF	Bright Setting
	Up	8x 01 04 0D 02 FF	
	Down	8x 01 04 0D 03 FF	
	Direct	8x 01 04 4D 00 00 0p 0q FF	pq: Bright l Positon (0~0x1B)
CAM_WDR	On	8x 01 04 3D 02 FF	Exposure Compensation ON/OFF
	Off	8x 01 04 3D 03 FF	
	Direct	8x 01 04 D3 pq FF	pq: ExpComp Position (0~0x6)
CAM_Back Light(BLC)	On	8x 01 04 33 02 FF	BackLight On
	Off	8x 01 04 33 03 FF	BackLight Off
CAM_Sharpness	Reset	8x 01 04 02 00 FF	Aperture Control
	Up	8x 01 04 02 02 FF	
	Down	8x 01 04 02 03 FF	
	Direct	8x 01 04 42 00 00 0p 0q FF	pq: Aperture Gain (0~0x0F)
CAM_Memory(preset)	Reset	8x 01 04 3F 00 pp FF	pp: Preset Number(=0 to 127) Corresponds to 0 to 9 on the Remote Commander
	Set	8x 01 04 3F 01 pp FF	
	Recall	8x 01 04 3F 02 pp FF	
CAM_LR_Reverse	On	8x 01 04 61 02 FF	Image Flip Horizontal ON/OFF
	Off	8x 01 04 61 03 FF	
CAM_Picture Flip	On	8x 01 04 66 02 FF	Image Flip Vertical ON/OFF
	Off	8x 01 04 66 03 FF	
CAM_RS485Ctl	On	8x 01 06 A5 02 FF	
	Off	8x 01 06 A5 03 FF	
CAM_Saturation	Saturation	8x 01 04 A1 00 00 0p 0q FF	pq:saturation level 0x00~0x0f
CAM_Contrast	Contrast	8x 01 04 A2 00 00 0p 0q FF	pq:Contrast level 0x00~0x0f

Command type	function	command	
CAM_Speed By Zoom	On	8x 01 06 A0 02 FF	
	Off	8x 01 06 A0 03 FF	
CAM_PT Speed	PT Speed	8x 01 04 C1 00 00 0p 0q FF	pq: PT speed 0x05~0x18
CAM_Zoom Speed	Zoom Speed	8x 01 04 D1 00 00 0p 0q FF	pq: Zoom speed 0x01~0x07
CAM_Zoom Display	On	8x 01 06 C2 02 FF	
	Off	8x 01 06 C2 03 FF	
CAM_Freeze	Freeze	8x 01 04 75 0p FF	p: Freeze switch 3=OFF, 2=ON
CAM_Preset Freeze Set	Preset Freeze Set	8x 01 04 76 0p FF	p: Preset Freeze switch 3=OFF, 2=ON
CAM_Preset Speed Set	Preset Speed Set	8x 01 7E 01 0B pp qq FF	pp: Preset NO. qq: Preset Speed 2~24 default:15
CAM_Preset Speed Adj	Preset Speed Adj	8x 01 7E 01 1B 0p FF	p: Adjustment of direction 3=down, 2=up
CAM_IR address	IR address	8x 01 06 D8 0p FF	p:IR address 1~4
CAM_Gamma	Gamma set	8x 01 04 5B 0p FF	P:Gamma NO. (0~4)
CAM_2D Noise Reduction	Direct	8x 01 04 A5 0p FF	(0~0x01)
CAM_3D Noise Reduction	Direct	8x 01 04 53 0p FF	(0~0x05)
FLICK	50HZ	8x 01 04 23 01 FF	
	60HZ	8x 01 04 23 02 FF	
	OFF	8x 01 04 23 00 FF	
Video System Set(Factory)		8x 01 06 35 00 pp FF	pp: Video format 1080P60 0x00 1080P50 0x01 1080I60 0x02 1080I50 0x03 1080P30 0x04 1080P25 0x05 720P60 0x06 720P50 0x07 720P30 0x08 720P25 0x09 1080P5994 0x0E 1080I5994 0x0F 1080P2997 0x10 720P5994 0x13 720P2997 0x14 1080P24 0x11 1080P2398 0x12
Video System Set(Sony)		8x 01 04 24 72 0p 0q FF	pq: Video format 1080P60 0x2e 1080P50 0x2f 1080I60 0x01 1080I50 0x04 1080P30 0x06 1080P25 0x08 720P60 0x09 720P50 0x0e 720P30 0x0e 720P25 0x11 1080P5994 0x13 1080I5994 0x02 1080P2997 0x07 720P5994 0x0a

Command type	function	command	
			720P2997 0x0f 1080P24 0x2a 1080P2398 0x2b
CAM_ID Write		8x 01 04 22 0p 0q 0r 0s FF	pqrs: Camera ID (=0000 to FFFF)
DHCP control	DHCP off	8x 01 04 AE 00 FF	DHCP off
	DHCP on	8x 01 04 AE 01 FF	DHCP on
IP address control	IP set	8x 01 04 AB 0p 0q 0r 0s 0m 0n 0x 0y FF	Set ip to :pq.rs.mn.xy
	Mask set	8x 01 04 AC 0p 0q 0r 0s 0m 0n 0x 0y FF	Set mask to :pq.rs.mn.xy
	Gateway set	8x 01 04 AD 0p 0q 0r 0s 0m 0n 0x 0y FF	Set gateway to : pq.rs.mn.xy
Mainstream	resolution	8x 01 04 C2 00 0p 0q 0r 0s 0m 0n 0x 0y FF	pqrs : Column(x size) mnxy: Line (y size) only support: 1920*1080 1280*720 1024*576
	rate	8x 01 04 C2 01 0p 0q 0r 0s 0m 0n 0x 0y FF	pqrsmnxy: bitrate (1024~16384kbps)
	Encode Mode	8x 01 04 C2 02 0p 0q FF	Mode sel:0xpq 0x00:h264 0x01:h265
	Frame Rate	8x 01 04 C2 03 0p 0q FF	Frame rate:0xpq (3~60)
	IDR	8x 01 04 C2 04 0p 0q FF	IDR Setting:0xpq (3~120)
	Stream Rate Mode	8x 01 04 C2 05 0p 0q FF	Contor mode:0xpq 0x00:CBR 0x01:VBR
Sub stream	resolution	8x 01 04 C3 00 0p 0q 0r 0s 0m 0n 0x 0y FF	pqrs : Column(x size) mnxy: Line (y size) only support: 640*360
	rate	8x 01 04 C3 01 0p 0q 0r 0s 0m 0n 0x 0y FF	pqrsmnxy: bitrate (1024~2048kbps)
	Encode Mode	8x 01 04 C3 02 0p 0q FF	Mode sel:0xpq 0x00:h264 0x01:h265
	Frame Rate	8x 01 04 C3 03 0p 0q FF	Frame rate:0xpq (3~60)
	IDR	8x 01 04 C3 04 0p 0q FF	IDR Setting:0xpq (3~120)
	Stream Rate Mode	8x 01 04 C3 05 0p 0q FF	Contor mode:0xpq 0x00:CBR 0x01:VBR
Color adjust	Color adjust OFF	8x 01 04 B6 00 FF	Color adjust off
	Color adjust ON	8x 01 04 B6 01 FF	Color adjust on
	brightness balance OFF	8x 01 04 B7 00 FF	Keep Brightness
	brightness balance ON	8x 01 04 B7 01 FF	No keep Brightness
	Flare red	8x 01 04 B8 dat FF	Flare mode red value Default is 32
	Flare green	8x 01 04 B9 dat FF	Flare mode green value Default is 32
	Flare blue	8x 01 04 BA dat FF	Flare mode blue value Default is 32
SYS_Menu	Menu On	8x 01 06 06 02 FF	Turn on the menu
	Menu Off	8x 01 06 06 03 FF	Turn off the menu
	Menu Back	8x 01 06 06 10 FF	Menu step back



Command type	function	command	
	Menu OK	8x 01 7E 01 02 00 01 FF	Menu ok
IR_Receive	On	8x 01 06 08 02 FF	IR(remote commander)receive ON/OFF
	Off	8x 01 06 08 03 FF	
	On/Off	8x 01 06 08 10 FF	
Cam_Tally	RGB	8x 01 7E 01 0A 00 0p FF	P=0: OFF P=1: RED P=2: GREEN P=3: RED&GREEN P=4: BLUE P=5: RED&BLUE P=6: GREEN&BLUE P=7: RED&GREEN&BLUE
Pan_tilt Drive	Up	8x 01 06 01 VV WW 03 01 FF	VV: Pan speed 0x01 (low speed) to 0x18 (high speed) WW: Tilt speed 0x01 (low speed) to 0x14 (high speed) YYY: Pan Position(TBD) ZZZ: Tilt Position(TBD)
	Down	8x 01 06 01 VV WW 03 02 FF	
	Left	8x 01 06 01 VV WW 01 03 FF	
	Right	8x 01 06 01 VV WW 02 03 FF	
	Up left	8x 01 06 01 VV WW 01 01 FF	
	Up right	8x 01 06 01 VV WW 02 01 FF	
	Down Left	8x 01 06 01 VV WW 01 02 FF	
	Down Right	8x 01 06 01 VV WW 02 02 FF	
	Stop	8x 01 06 01 VV WW 03 03 FF	
	Absolute Position	8x 01 06 02 VV WW 0Y 0Y 0Y 0Y 0Z 0Z 0Z 0Z FF	
	Relative Position	8x 01 06 03 VV WW 0Y 0Y 0Y 0Y 0Z 0Z 0Z 0Z FF	
	Home	8x 01 06 04 FF	
Reset	8x 01 06 05 FF		
Pan-tilt Limit Set	Set	8x 01 06 07 00 0W 0Y 0Y 0Y 0Y 0Z 0Z 0Z 0Z FF	W:1 Up Right 0:Down Left YYY: Pan Limit Position(TBD) ZZZ: Tilt Limit Position(TBD)
	Clear	8x 01 06 07 01 0W 07 0F 0F 0F 07 0F 0F 0F FF	

### Part 3 Camera Inquiry Command

Command type	command	return	note
CAM_Power Inq	8x 09 04 00 FF	y0 50 02 FF	On
		y0 50 03 FF	Off(Standby)
CAM_Zoom Pos Inq	8x 09 04 47 FF	y0 50 0p 0q 0r 0s FF	pqr: Zoom Position
CAM_DZoom On Off Inq	8x 09 04 06 FF	y0 50 0p FF	p 2: ON 3: OFF
CAM_DZoom Mode Inq	8x 09 04 36 FF	y0 50 0p FF	p 0:combination mode 1:separate mode
CAM_DZoom Posi Inq	8x 09 04 46 FF	y0 50 0p 0q 0r 0s FF	pqr: Zoom Position
CAM_Speed By Zoom Inq	8x 09 06 A0 FF	y0 50 0p FF	p 2: ON 3: OFF
CAM_PT Speed Inq(IR)	8x 09 04 C1 FF	y0 50 pp FF	pp: 0x05~0x18
CAM_Zoom Speed Inq(IR)	8x 09 04 D1 FF	y0 50 0p FF	p:0x00~0x07
CAM_Focus Mode Inq	8x 09 04 38 FF	y0 50 02 FF	Auto Focus
		y0 50 03 FF	Manual Focus

CAM_Focus Pos Inq	8x 09 04 48 FF	y0 50 0p 0q 0r 0s FF	pqrs: Focus Position
CAM_2D_Inq	8x 09 04 A5 FF	y0 50 03 FF	(0-0x01) p: 0: off 1: on
CAM_3D_Inq	8x 09 04 53 FF	y0 50 03 FF	(0-0x05) p:0:off 1: auto 2-5: noise level
CAM_WB Mode Inq	8x 09 04 35 FF	y0 50 00 FF	Auto
		y0 50 01 FF	Indoor mode
		y0 50 02 FF	Outdoor mode
		y0 50 03 FF	OnePush mode
		y0 50 04 FF	ATW
y0 50 05 FF	Manual		
CAM_RGain Inq	8x 09 04 43 FF	y0 50 00 00 0p 0q FF	pq: R Gain
CAM_BGain Inq	8x 09 04 44 FF	y0 50 00 00 0p 0q FF	pq: B Gain
CAM_Saturation Inq	8x 09 04 A1 FF	y0 50 00 00 0p 0q FF	pq: saturation
CAM_Contrast Inq	8x 09 04 A2 FF	y0 50 00 00 0p 0q FF	pq: contrast
CAM_AE Mode Inq	8x 09 04 39 FF	y0 50 00 FF	Full Auto
		y0 50 03 FF	Manual
		y0 50 0A FF	Shutter priority
		y0 50 0B FF	Iris priority
		y0 50 0D FF	Bright
CAM_Flicker Mode Inq	8x 09 04 AA FF	y0 50 0p FF	p 0: OFF 1: 50HZ 2: 60HZ
CAM_Shutter Pos Inq	8x 09 04 4A FF	y0 50 00 00 0p 0q FF	pq: Shutter Position
CAM_Iris Pos Inq	8x 09 04 4B FF	y0 50 00 00 0p 0q FF	pq: Iris Position
CAM_Gain Posi Inq	8x 09 04 4C FF	y0 50 00 00 0p 0q FF	pq: Gain Position
CAM_Bright Posi Inq	8x 09 04 4D FF	y0 50 00 00 0p 0q FF	pq: Bright Position
CAM_WDR Mode Inq	8x 09 04 3D FF	y0 50 02 FF	On
		y0 50 03 FF	Off
CAM_WDR Pos Inq	8x 09 04 D3 FF	y0 50 0p FF	p: WDR Position
CAM_Aperture Inq	8x 09 04 42 FF	y0 50 00 00 0p 0q FF	pq: Aperture Gain
CAM_Preset Exist Inq	8x 09 04 3F pp FF	y0 50 0q FF	pp: Memory number q: 1=preset exist 0=preset not saved
SYS_Menu Mode Inq	8x 09 06 06 FF	y0 50 02 FF	On
		y0 50 03 FF	Off
CAM_LR_Reverse Inq	8x 09 04 61 FF	y0 50 02 FF	On
		y0 50 03 FF	Off
CAM_Picture Flip Inq	8x 09 04 66 FF	y0 50 02 FF	On
		y0 50 03 FF	Off
CAM_ID Inq	8x 09 04 22 FF	y0 50 0p 0q 0r 0s FF	pqrs: Camera ID
CAM_DHCP Inq	8x 09 04 AE FF	y0 50 pp FF	
CAM_IP Inq	8x 09 04 AB FF	y0 50 0p 0p 0q 0q 0r 0r 0s 0s FF	
CAM_MASK Inq	8x 09 04 AC FF	y0 50 0p 0p 0q 0q 0r 0r 0s 0s FF	
CAM_GATEWAY Inq	8x 09 04 AD FF	y0 50 0p 0p 0q 0q 0r 0r 0s 0s FF	
CAM_Flare Mode Inq	8x 09 04 B6 FF	y0 50 pp FF	
CAM_Flare Bright Mode Inq	8x 09 04 B7 FF	y0 50 pp FF	
CAM_Flare Red	8x 09 04 B8 FF	y0 50 pp FF	
CAM_Flare Green	8x 09 04 B9 FF	y0 50 pp FF	
CAM_Flare Blue	8x 09 04 BA FF	y0 50 pp FF	
CAM_Version Inq	8x 09 00 02 FF	y0 50 ab cd	

		mn pq rs tu vw FF	
Video System Inq(Factory)	8x 09 06 23 FF	y0 50 pp FF	pp: Video format
Video System Inq(Sony)	8x 09 04 24 72 FF	y0 50 0p 0p FF	pp: Video format
IR_Transfer	8x 09 06 1A FF	y0 50 02 FF	On
		y0 50 03 FF	Off
IR_Receive	8x 09 06 08 FF	y0 50 02 FF	On
		y0 50 03 FF	Off
Pan-tilt Max Speed Inq	8x 09 06 11 FF	y0 50 ww zz FF	ww: Pan Max Speed zz: Tilt Max Speed
Pan-tilt Pos Inq	8x 09 06 12 FF	y0 50 0w 0w 0w 0w 0z 0z 0z 0z FF	www: Pan Position zzzz: Tilt Position
Mainstream Resolution Inq	8x 09 04 C2 00 FF	y0 50 0p 0q 0r 0s 0m 0n 0x 0y FF	pqrs : Column(x size) mnyx: Line (y size) only support: 1920*1080 1280*720 1024*576
Main stream Rate Inq	8x 09 04 C2 01 FF	y0 50 0p 0q 0r 0s 0m 0n 0x 0y FF	pqrsmnxy: bitrate (1024~16384kbps)
Main Encode Mode Inq	8x 09 04 C2 02 FF	y0 50 pp FF	Mode sel:0xpp 0x00:h264 0x01: h265
Main Frame Rate Inq	8x 09 04 C2 03 FF	y0 50 pp FF	Frame rate:0xpp (3~60)
Main IDR Inq	8x 09 04 C2 04 FF	y0 50 pp FF	IDR Setting:0xpp (3~120)
Main Stream Rate Mode Inq	8x 09 04 C2 05 FF	y0 50 pp FF	Contor mode:0xpp 0x00:CBR 0x01:VBR
Sub stream Resolution Inq	8x 09 04 C3 00 FF	y0 50 0p 0q 0r 0s 0m 0n 0x 0y FF	pqrs : Column(x size) mnyx: Line (y size) only support: 640*360
Sub stream Rate Inq	8x 09 04 C3 01 FF	y0 50 0p 0q 0r 0s 0m 0n 0x 0y FF	pqrsmnxy: bitrate (1024~2048kbps)
Sub Encode Mode Inq	8x 09 04 C3 02 FF	y0 50 pp FF	Mode sel:0xpp 0x00:h264 0x01: h265
Sub Frame Rate Inq	8x 09 04 C3 03 FF	y0 50 pp FF	Frame rate:0xpp (3~60)
Sub ID RInq	8x 09 04 C3 04 FF	y0 50 pp FF	IDR Setting:0xpp (3~120)
Sub Stream Rate Mode Inq	8x 09 04 C3 05 FF	y0 50 pp FF	Contor mode:0xpp 0x00:CBR 0x01:VBR

**Note:** **[x]** means the camera address ; **[y]** = **[x + 8]** .

**VISCA PAN TILT ABSOLUTE POSITION VALUE**

Pan Angle	VISCA Value	Tilt Angle	VISCA Value
-170	0xF670	-30	0xFE50
-135	0xF868	0	0x0000
-90	0xFAF0	30	0x01B0
-45	0xFD78	60	0x0360
0	0x0000	90	0x510
45	0x0288		
90	0x0510		
135	0x0798		
170	0x0990		

**VISCA PAN TILT SPEED VALUE**

Pan(Degree/Second)		Pan(Degree/Second))	
0	0.3	0	0.3
1	1	1	1
2	1.5	2	1.5
3	2.2	3	2.2
4	2.4	4	3.6
5	2.6	5	4.7
6	2.8	6	6
7	3.0	7	8
8	3.2	8	10
9	3.4	9	12
10	3.8	10	15
11	4.5	11	18
12	6	12	23
13	9	13	30
14	15	14	39
15	19	15	48
16	25	16	59
17	32	17	69
18	38	18	80
19	45		
20	58		
21	75		
22	88		
23	105		
24	120		

## PELCO-D Protocol Command List

Function	Byte1	Byte2	Byte3	Byte4	Byte5	Byte6	Byte7
Up	0xFF	Address	0x00	0x08	Pan Speed	Tilt Speed	SUM
Down	0xFF	Address	0x00	0x10	Pan Speed	Tilt Speed	SUM
Left	0xFF	Address	0x00	0x04	Pan Speed	Tilt Speed	SUM
Right	0xFF	Address	0x00	0x02	Pan Speed	Tilt Speed	SUM
Up left	0xFF	Address	0x00	0x0C	Pan Speed	Tilt Speed	SUM
Up right	0xFF	Address	0x00	0x0A	Pan Speed	Tilt Speed	SUM
Down Left	0xFF	Address	0x00	0x14	Pan Speed	Tilt Speed	SUM
Down Right	0xFF	Address	0x00	0x12	Pan Speed	Tilt Speed	SUM
Zoom In	0xFF	Address	0x00	0x20	0x00	0x00	SUM
Zoom Out	0xFF	Address	0x00	0x40	0x00	0x00	SUM
Focus Far	0xFF	Address	0x00	0x80	0x00	0x00	SUM
Focus Near	0xFF	Address	0x01	0x00	0x00	0x00	SUM
Set Preset	0xFF	Address	0x00	0x03	0x00	Preset ID	SUM
Stop	0xFF	Address	0x00	0x00	Pan Speed	Tilt Speed	SUM
Clear Preset	0Xff	Address	0x00	0x05	0x00	Preset ID	SUM
Call Preset	0Xff	Address	0x00	0x07	0x00	Preset ID	SUM
Query Pan Position	0Xff	Address	0x00	0x51	0x00	0x00	SUM
Query Pan Position Response	0Xff	Address	0x00	0x59	Value High Byte	Value Low Byte	SUM
Query Tilt Position	0Xff	Address	0x00	0x53	0x00	0x00	SUM
Query Tilt Position Response	0Xff	Address	0x00	0x5B	Value High Byte	Value Low Byte	SUM
Query Zoom Position	0Xff	Address	0x00	0x55	0x00	0x00	SUM
Query Zoom Position Response	0Xff	Address	0x00	0x5D	Value High Byte	Value Low Byte	SUM

## PELCO-P Protocol Command List

Function	Byte1	Byte2	Byte3	Byte4	Byte5	Byte6	Byte7	Byte8
Up	0Xa0	Address	0x00	0x08	Pan Speed	Tilt Speed	0Xaf	XOR
Down	0Xa0	Address	0x00	0x10	Pan Speed	Tilt Speed	0Xaf	XOR
Left	0Xa0	Address	0x00	0x04	Pan Speed	Tilt Speed	0Xaf	XOR
Right	0Xa0	Address	0x00	0x02	Pan Speed	Tilt Speed	0Xaf	XOR
Up left	0Xa0	Address	0x00	0x0C	Pan Speed	Tilt Speed	0Xaf	XOR
Up right	0Xa0	Address	0x00	0x0A	Pan Speed	Tilt Speed	0Xaf	XOR
Down Left	0Xa0	Address	0x00	0x14	Pan Speed	Tilt Speed	0Xaf	XOR
Down Right	0Xa0	Address	0x00	0x12	Pan Speed	Tilt Speed	0Xaf	XOR
Zoom In	0Xa0	Address	0x00	0x20	0x00	0x00	0Xaf	XOR
Zoom Out	0Xa0	Address	0x00	0x40	0x00	0x00	0Xaf	XOR
Focus Far	0Xa0	Address	0x00	0x80	0x00	0x00	0Xaf	XOR
Focus Near	0Xa0	Address	0x01	0x00	0x00	0x00	0Xaf	XOR
Stop	0Xa0	Address	0x00	0x00	Pan Speed	Tilt Speed	0Xaf	XOR
Set Preset	0xA0	Address	0x00	0x03	0x00	Preset ID	0xAF	XOR
Clear Preset	0xA0	Address	0x00	0x05	0x00	Preset ID	0xAF	XOR
Call Preset	0xA0	Address	0x00	0x07	0x00	Preset ID	0xAF	XOR
Query Pan Position	0xA0	Address	0x00	0x51	0x00	0x00	0xAF	XOR
Query Pan Position Response	0xA0	Address	0x00	0x59	Value High Byte	Value Low Byte	0xAF	XOR
Query Tilt Position	0xA0	Address	0x00	0x53	0x00	0x00	0xAF	XOR
Query Tilt Position Response	0xA0	Address	0x00	0x5B	Value High Byte	Value Low Byte	0xAF	XOR
Query Zoom Position	0xA0	Address	0x00	0x55	0x00	0x00	0xAF	XOR
Query Zoom Position Response	0xA0	Address	0x00	0x5D	Value High Byte	Value Low Byte	0xAF	XOR

## OSD MENU

1. Under working mode, press the MENU key on the IR remote controller, to enter the OSD menu as below:

MENU	
SYSTEM	PROTOCOL < VISCA >
EXPOSURE	ADDRESS < 001 >
IMAGE	BAUDRATE < 9600 >
QUALITY	PTL LOCK < OFF >
PTZ	RS485 < ON >
FORMAT	VISCA < OVER ALL >
IP	LANGUAGE < ENGLISH >
RESET	
INFO	

2. After enter the main menu, use the navigate UP/DOWN key to select the main menu. Once been selected, the main menu will change to blue background, and the right side will show all sub menu options.

3. Press the navigate RIGHT key to enter sub menu; use UP/DONW key to select the sub menu; use LEFT/RIGHT key to select parameter.

4. Press the MENU key again to return to previous menu. Press the MENU key continuously to exit the OSD menu.

### 5. OSD Menu Setting List

SYSTEM	PROTOCOL	Optional item: VISCA、PLC.P、PLC.D	Default: VISCA
	ADDRESS	VISCA:1~7      PLC.P/PLC.D:1~255	Default: 1
	BAUD RATE	Optional item:2400、4800、9600、115200	Default: 9600
	PTL LOCK	Protocol lock: once set, above protocol setting will be locked	Default: OFF
	RS485	RS485 ON/OFF	Default: ON
	VISCA	Optional Item: OVER ALL、OVER IP、OVER COM	Default: OVER ALL
	LANGUAGE	Optional Item: Chinese、English	Default: English

EXPOSURE	EXPOSURE MODE	AUTO、MANUAL、SHUTTER、IRIS、BRIGHT	Default: AUTO
	SHUTTER	Shutter speed: 1/30~1/10000, only valid under MANUAL and SHUTTER mode	Default: AUTO
	IRIS	Iris setting: CLOSE~F1.8, only valid under MANUAL and IRIS mode	Default: AUTO
	GAIN	Gain setting: 0dB~30dB , only valid under MANUAL mode	Default: AUTO
	EBRIGHT	Bright setting: 0~27, only valid under BRIGHT priority mode.	Default: AUTO
	BRIGHT	0~15	Default: 8
	WD MODE	ON/OFF	Default: OFF
	WD LEVEL	WDR Level	Default: 1
	BLC	ON/OFF	Default: OFF

IMAGE	WB MODE	Optional: ATW、MANUAL、AUTO、INDOOR、OUTDOOR、PUSH	Default: ATW
	R GAIN	Red gain level: 0~255, only valid under manual white balance mode	Default: AUTO
	B GAIN	Blue gain level:0~255 , only valid under manual white balance mode	Default: AUTO
	FLICK	Anti-Flicker setting:50/60HZ, to reduce the video flicker	Default: 50HZ
	DZOOM	ON/OFF	Default: OFF
	FOCUS	Select focus mode	Default: AUTO

QUALITY	2D NR	2D noise reduction: the bigger value is, the less noise on image is, the lower resolution is.	Default: OFF
	3D NR	3D noise reduction: OFF/AUTO/0~4, the bigger value is, the less motion noise on image is. High value will cause image smear.	Default: AUTO
	SHARPNESS	Sharpness setting: 0~15, the higher value is, edge of the image will be sharpen	Default: 3
	CONTRAST	Set contrast level	Default: 8
	SATURATION	Set saturation.	Default: 8
	GAMMA	Select gamma level	Default: 0
	AF SENSITIVITY	Optional: LOW/NORMAL/HIGH	Default: NORMAL

PTZ	SPEEDBYZ	Speed By Zoom: proportional speed, the bigger the zoom is, the slower the speed is	Default: ON
	FLIP.HOR	Flip horizontal	Default: OFF
	FLIP.VER	Flip vertical	Default: OFF
	PT SPD	Pan Tilt speed	Default: 18
	ZOOM SPD	Zoom speed	Default: 5
	MENU MIR	Optional Item: NORMAL、MIRROR	Default:NORMAL
	PRE FRZ	Open/Close Video Freeze when running presets	Default: OFF
	PRE PTSPD	Preset head speed: 2~24	Default: 15
	PRE ZSPD	Preset zoom speed: 1~7	Default: 5



FORMAT	1080P59.94	1080P50	After selecting the system, press OK to switch the system. If it is the currently selected system, it will not be activated
	1080I59.94	1080I50	
	1080P29.97	1080P25	
	720P59.94	720P50	
	720P29.97	720P25	
	1080P60	1080P30	
	720P60	720P30	
	1080I60	1080P24	

IP	DHCP	ON/OFF	Using up/down/left/right navigation button to select item to set, and using number button to set parameter.  Press menu button to return.
	IP	192.168.001.188	
	MASK	255.255.255.000	
	GW (Gateway)	192.168.001.001	
	MAIN	Default: 1920*1080	
	BITRATE	Default: 04096k	
	SUB	Default: 1280*720	
	BITRATE	Default: 02048k	

RESET	SYS RESET	Reset communication parameter to default
	CAM RESET	Reset camera parameter to default
	PT RESET	Reset pan/tilt parameter to default
	ALL RESET	Reset all parameter to default

INFO	IR ADDR	Camera IR control address
	USB	USB firmware version
	CLIENT	Default client end protocol: VISCA
	MODEL NO.	Model number
	ARM VER	ARM firmware version
	FPGA VER	FPGA firmware version
	CAM VER	Camera version
	RELEASE	Software release date

## Set IP Address in Menu

In order to facilitate customer debugging, the camera has the support menu to set IP address. The specific methods are as follows:

1. Press "MENU" to open the menu interface, select "network parameters" in the menu to call up the IP setting interface:

MENU	
SYSTEM	DHCP: < OFF >
EXPOSURE	IP : 192.168.001.188
IMAGE	MASK: 255.255.255.000
QUALITY	GW : 192.168.001.001
PTZ	MAIN : < 1920*1080 >
FORMAT	BITRATE: < 04096 K >
IP	SUB : < 1280*720 >
RESET	BITRATE: < 02048 K >
INFO	

2. Right click the remote control to enter the IP setting interface, and select the parameters to be set by using the navigation up and down keys, and then select the IP address, mask, gateway:
3. Short press the number key to set the corresponding parameters. After setting the current parameters, press the "MENU" key again to complete the current parameter setting:
4. To exit the menu, just press the "MENU" key again.

## UVC CONTROL

1. Only run the client software after the USB3.0 camera has completed self-configuration (the IR indicator in blue color and will not flash); otherwise may cause black video issue.
2. Make sure the USB3.0 camera is recognized by the PC Device Manager.
3. Make sure the interval of video format switching more than 3 seconds, otherwise black video maybe caused.
4. Make sure the interval of control command sending from the server (via USB) to the camera no less than 250ms.
5. Support standard UVC interface.

PU_BRIGHTNESS_CONTROL	81 01 04 4d 00 00 0p 0q FF
PU_CONTRAST_CONTROL	81 01 04 A2 00 00 0p 0q FF
PU_SATURATION_CONTROL	81 01 04 A1 00 00 0p 0q FF
PU_SHARPNESS_CONTROL	8x 01 04 42 00 00 0p 0q FF
PU_GAMMA_CONTROL	8x 01 04 5B 0p FF
PU_WHITE_BALANCE_TEMPERATURE_CONTROL	8x 01 04 35 0X FF
PU_BACKLIGHT_COMPENSATION_CONTROL	81 01 04 33 02/03 FF
PU_POWER_LINE_FREQUENCY_CONTROL	8x 01 04 AA 00/01/02 FF
CT_ZOOM_ABSOLUTE_CONTROL	8x 01 04 47 0p 0q 0r 0s FF
CT_PANTILT_ABSOLUTE_CONTROL	8x 01 06 02 VV WW 0Y 0Y 0Y 0Y 0Z 0Z 0Z F
CT_PANTILT_RELATIVE_CONTROL	8x 01 06 01 pp qq rr ss FF
CT_ZOOM_RELATIVE_CONTROL	8x 01 04 07 pp FF

## WEB SETTING

It is not necessary to install additional video player plug-in to preview the local screen on the web interface.

The web interface supports Google Chrome, Firefox, IE, Safari, Opera, 360, QQ and other browsers, adaptability is very good.

### 1. Login

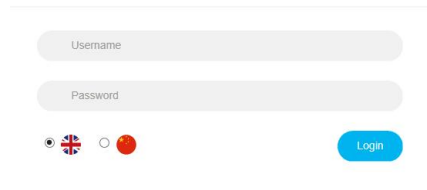

Run browser, input IP address (**defaulted IP address is 192.168.1.188**), to enter login interface, can select Language (Chinese or English), input admin and password to login as following: (**Default Username: admin**    **Default password: admin**)

## Camera Control



Username

Password

Login

### 2. Real-time Preview:

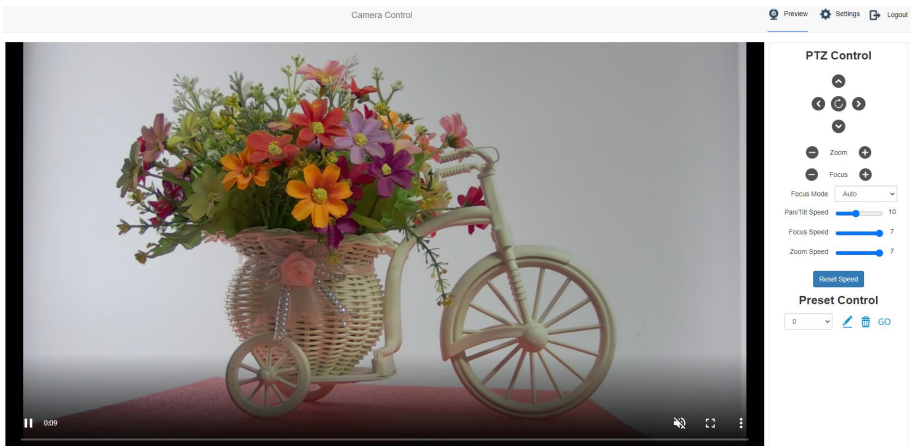

The preview interface is shown above. On the right side, with options to control camera pan, tilt, zoom, focus, focus mode, pan tilt speed, focus speed, zoom speed, preset position control, etc. At the bottom of the image, you can select the volume switch and volume level, as well as the full-size view and picture-in-picture mode.

### 3. Parameter Setting

Click “Setting” to enter into parameter setting interface as following:

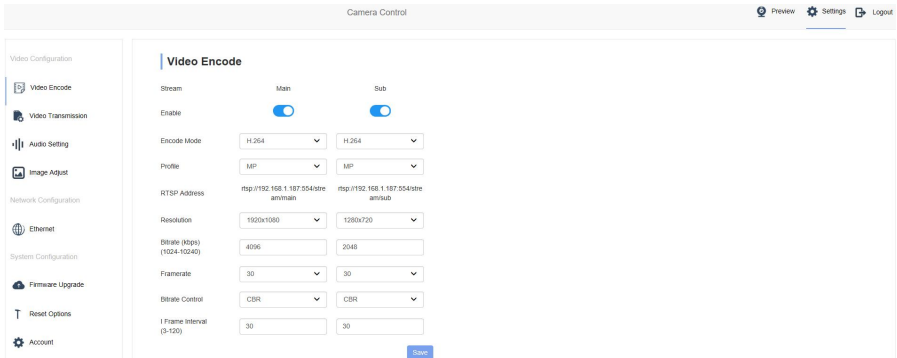

**"Video Encode"**: can set image encode mode, main stream and sub stream resolution/bit rate/frame rate, bit rate control way, and I frame interval etc as above image.

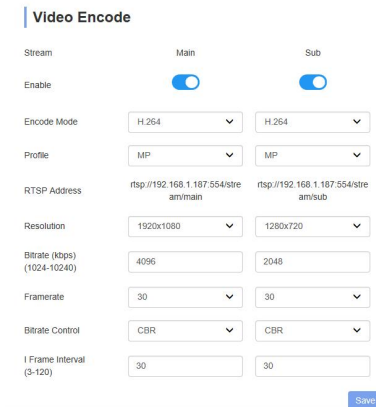

**"video Transmission"**: RTMP and NDI settings are available, as shown in the following figure:

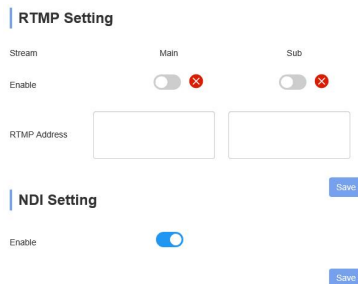

**"Audio Settings"**: the audio enable can be off/on, the encoding mode can be selected, and the parameters such as sampling rate and bit rate can be adjusted, as shown in the following figure:

### Audio Setting

Audio State

EncMode AAC ▾

samplerate 44100 ▾

bitrate 96000 ▾

Save

“Image Parameter” can set focus, exposure, white balance, image, image quality, noise-reduction, as following picture.

### Image Adjust



Focus Exposure White Balance Image Image Quality Noise Reduction

Focus Mode Auto ▾

Digital Zoom

Reset

Focus including focus mode, default focal distance, digital zoom etc

Focus Exposure White Balance Image Image Quality Noise Reduction

Focus Mode Auto ▾

Digital Zoom

Reset

Exposure includes exposure mode, shutter speed, gain, iris, brightness, and anti-flicker.

Focus Exposure White Balance Image Image Quality Noise Reduction

Exposure Mode Auto ▾ Gain 30dB ▾

Shutter 1/30 ▾ Iris F1.8 ▾

Anti-flicker  Brightness 8 ▾

Reset

White Balance includes white balance mode, red gain, blue gain.

Focus Exposure White Balance Image Image Quality Noise Reduction

WB Mode Auto Tracking ▾

Red Gain  58

Blue Gain  52

Reset

**Image** includes mirror, flip, backlight compensation, Gamma, WDR(wide dynamic range).

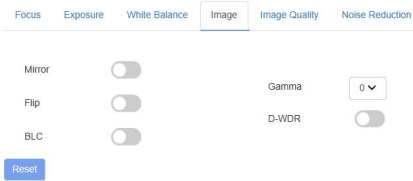

**Image Quality** includes brightness, sharpness, contrast, saturation.

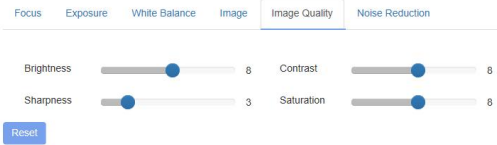

**Noise reduction** includes 2D/3D reduction. There is on/off option for 2D, and off/auto/1~4 six options.

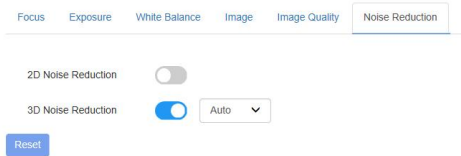

**“Ethernet”** includes DHCP mode, IP address, Net mask, Gateway, HTTP Port, RTSP Port, Visca Over IP. Default parameter as following:

DHCP	OFF	Gateway	192.168.1.1	RTSP Port	554
IP address	192.168.1.188	DNS	192.168.1.1	RTSP Encrypt	ON
Netmask	255.255.255.0	HTTP Port	80	Visca Over IP	52381

**“Firmware upgrade”**: it is for camera program upgrade, currently only for ISP part update. How to update:

As following picture, click “clicking to upload file” icon, open dialog box, select to open the file, and click “upgrade” to start.

DO NOT power off or do other operation when upgrading, reboot the camera after 5 min when upgrade finished.

Then login web end to select “reset all” to reset the camera completely.



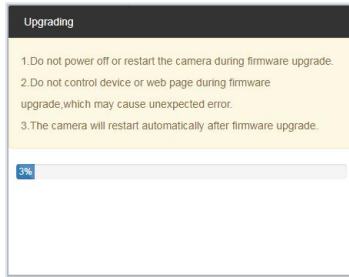

**Reset to default:** reset the camera to default setting

Reset simply: reset camera image parameter

Reset Completelyall: reset camera Ethernet and image parameter, language and protocol will not be reset.

Reboot: Reboot ISP part of camera

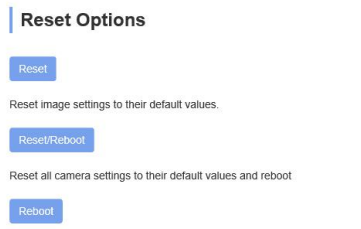

**Account Setting:** is used for setting camera account and password

Input the account firstly, then input same password twice, click set to finish

Please remember account and password, otherwise you may be not able to login.

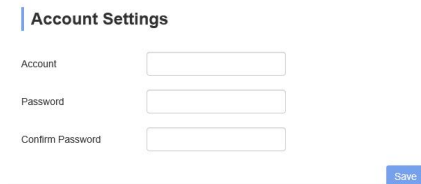

**System Time:** Set the time zone and NTP enable.

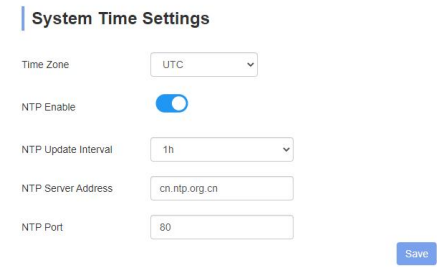

## VIEW RTSP VIDEO VIA VLC

Default RTSP main streaming address: `rtsp://192.168.1.188/stream/main`

Default RTSP sub streaming address: `rtsp://192.168.1.188/stream/sub`

Default RTMP main streaming address: `rtmp://192.168.1.188:1935/app/rtmpstream0`

Default RTMP sub streaming address: `rtmp://192.168.1.188:1935/app/rtmpstream1`

1, Run VLC Media Player.

2, Media->network stream, to enter into “open media” interface.

3, Input RTSP address in URL as following:



4, Click play to view the real time image.

Note: If there is much image lag, select “more option” to enter into following setting, change buffer time smaller (VLC default buffer time is 1000ms).





# NewTek Tools Guide

## 1. Image Preview

- A. Download the NewTek NDI Tools via <https://ndi.tv/tools/> and install it.
- B. Find out the NDI 4.5 Tools/Studio Monitor via Windows toolbars, and then open it, as below:



- C. Right click on the Studio Monitor screen, select the preview device:

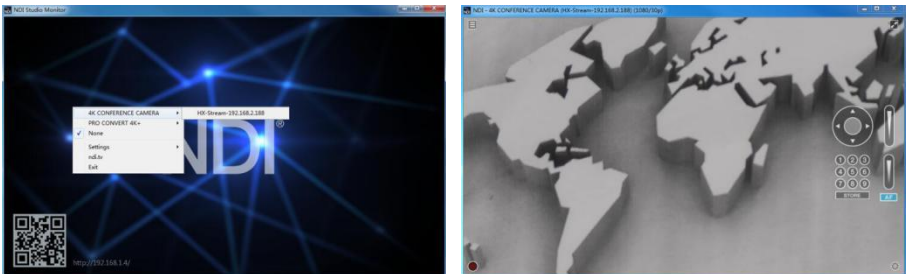

## 2. Pan Tilt Control

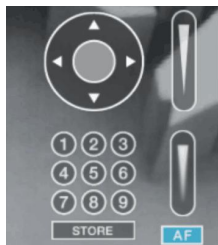

Refer to above picture, once open the video via Studio Monitor, it will show up the control panel on the right side, to control camera pan, tilt, zoom, focus, preset, focus.

## 3. Run WEB via Studio Monitor

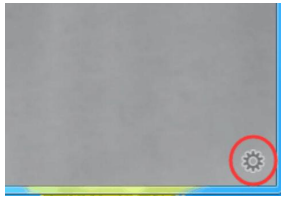

Refer to above picture, once open the video via Studio Monitor, there will show up a setting icon at the lower right corner, single click this icon to enter WEB UI.

#### 4. How to use NDI tools to Virtual Input CAMERA

A. find out the NDI 4.5 Tools/Virtual Input via Windows toolbars, open it, then it will show up the NDI Virtual Input icon at the Windows toolbars, as bellow picture shows:



B. Right click on the NDI Virtual Input icon, to select the virtual device name:

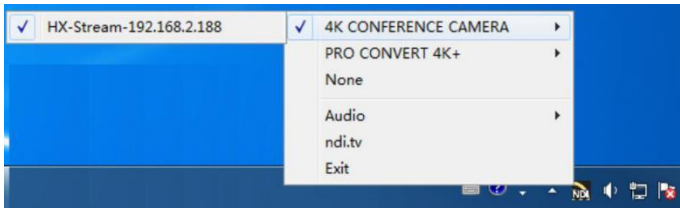

C. Take Zoom for example, select NewTek NDI Video as video camera, as bellow picture shows:

This also work for other applications, such as GotoMeeting, Skype for Business, Hangouts.



## VISCA OVER IP

VISCA over IP means VISCA protocol transmit via IP, to reduce RS232/RS485 cable layout (the controller must support IP communication function)

Communication port spec:

- Control port: RJ45 Gigabit LAN
- IP protocol: IPv4
- Transmit protocol: UDP
- IP address: set via web end or OSD menu
- Port address: 52381
- Confirm send/transmission control: depend on applied program
- Applied range: in the same segment, not suitable for bridge network
- Turn on camera: In the menu, set VISCA option to OVER IP

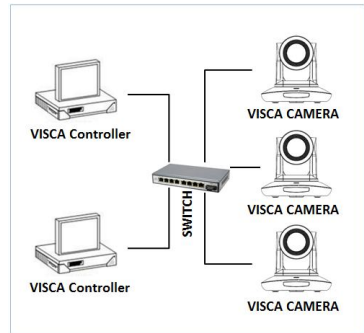

### How to use VISCA over IP

#### VISCA Command

It means commands from controller to peripheral equipment, when peripheral equipment receives commands, then return ACK. When commands executed, will return complete message.

For different commands, camera will return different message.

#### VISCA Inquiry

It means inquiry from controller to peripheral equipment when peripheral equipment receives this kind of commands, it will return required message.

#### VISCA Reply

It means ACK, complete message, reply or error reply, it is sent from peripheral equipment to controller.

**Command format:** the following is message head and valid message format.

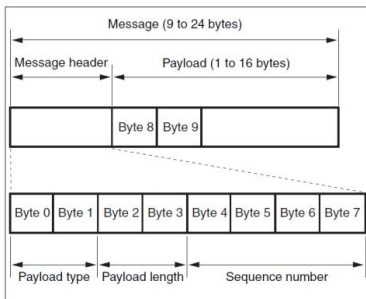

Note: LAN output way is big-endian, LSB is in the front.

### Payload type:

Data definition as following:

Name	Value (Byte 0)	Value (Byte 0)	Value (Byte 0)
VISCA command	0x01	0x00	Stores the VISCA command.
VISCA inquiry	0x01	0x10	Stores the VISCA inquiry.
VISCA reply	0x01	0x11	Stores the reply for the VISCA command and VISCA inquiry, or VISCA device setting command.
VISCA device setting command	0x01	0x20	Stores the VISCA device setting command.
Control command	0x02	0x00	Stores the control command.
Control reply	0x02	0x01	Stores the reply for the control command.

### Payload length

Valid data length in Payload (1~16), is command length.

For example, when valid data length is 16 byte

Byte 2 : 0x00

Byte 3 : 0x10

Controller will save sequence number of each command, when one command sent, the sequence number of the command will add 1, when the sequence number becomes the max value, it will change to 0 for next time. The peripheral equipment will save sequence number of each command, and return the sequence number to the controller.

### Payload

According to Payload type, the following data will be saved.

- VISCA command  
Save VISCA command packet
- VISCA inquiry  
Save VISCA message packet
- VISCA reply  
Save VISCA return packet
- VISCA device setting command  
Save VISCA equipment setting command packet.
- Control command

The following data is saved in control command payload

Name	Value	Description
RESET	0x01	Resets the sequence number to 0. The value that was set as the sequence number is ignored.
ERROR	0x0Fyy	yy=01:Abnormality in the sequence number.
		yy=02:Abnormality in the message(message type).

- Controlled reply

The following data is saved in return command payload of control command.

Message	Value	Description
ACK	0x01	Reply for RESET.

### Delivery confirmation

VISCA over IP uses UDP as transmission communication protocol, UDP communication message transmission is not stable, it is necessary to confirm delivery and resent in application.

Generally, when controller sends a command to peripheral equipment, controller will wait for the return message then send the next command, we can detect and confirm if the peripheral equipment receive the commands from return message's lag time. If controller shows it is overtime, it is regarded as error transmission.

If controller shows it is overtime, resend the commands to check peripheral's status, resent command sequence number is same as last command, the following chart list the received message and status after resending the commands.

Lost message	Received message for retransmission	Status after retransmission	Correspondence after retransmission
Command	ACK message	Command is performed by retransmission.	Continue processing.
Completion message For the command	ERROR(Abnormality in the sequence number.)	Command has been performed. If only the ACK message is lost, the completion message returns.	If the result by the completion message is needed, retransmit by updating the sequence number.
Completion message for the command	ERROR(Abnormality in the sequence number.)	Command has been performed.	If the result by the completion message is needed, retransmit by updating the sequence number.
Inquiry	Reply message	Inquiry is performed by retransmission.	Continue processing.
Reply message for the inquiry	ERROR(Abnormality in the sequence number.)	Inquiry has been performed.	If the result by the reply message is needed, retransmit by updating the sequence number.
Error message	Error message	Command is not performed. If the error cause eliminates, normal reply is return(ACK, reply message)	Eliminate the error cause. If normal reply returns, continue processing.
Inquiry of the VISCA device setting command	Reply message of the VISCA device setting command	Inquiry has been performed by retransmission.	Continue processing.
Reply message of the VISCA device setting command	ERROR(Abnormality in the sequence number.)	Inquiry has been performed.	If the result by the reply message is needed, retransmit by updating the sequence number.

Sequence chart as following

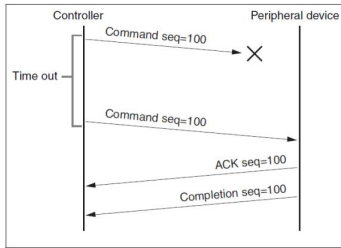

Sequence chart when command lost

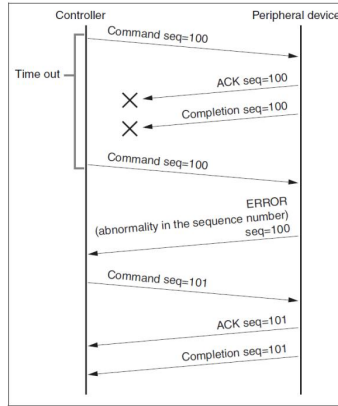

Sequence chart when returned message lost

Note: Do not set IP address, sub net mask, gateway parameter in VISCA over IP command, otherwise, it will cause network breaks off. Due to change these parameter, network will be in off status.



